

WHO
WHEN
WHY
NOW
HOW
WHAT
WHERE
WOW

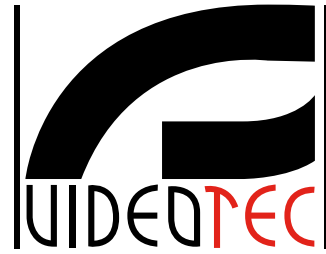

OUR COMPANY OUR PROFILE

An icon of **QUALITY**

Since 1986 Videotec designs and creates state-of-the-art products for the professional video surveillance industry.

In over the years, we have designed, created and patented numerous products for monitoring all types of outdoor environment.

Today, our company is an icon of quality and design, thanks to our incessant effort for innovation and development of CCTV solutions that guarantee security.

Videotec is an ISO 9001:2000 company.

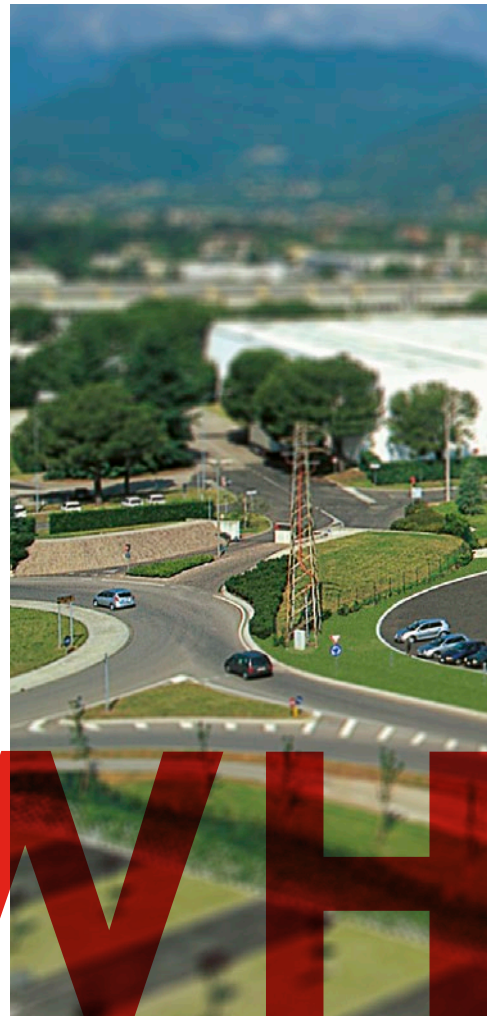
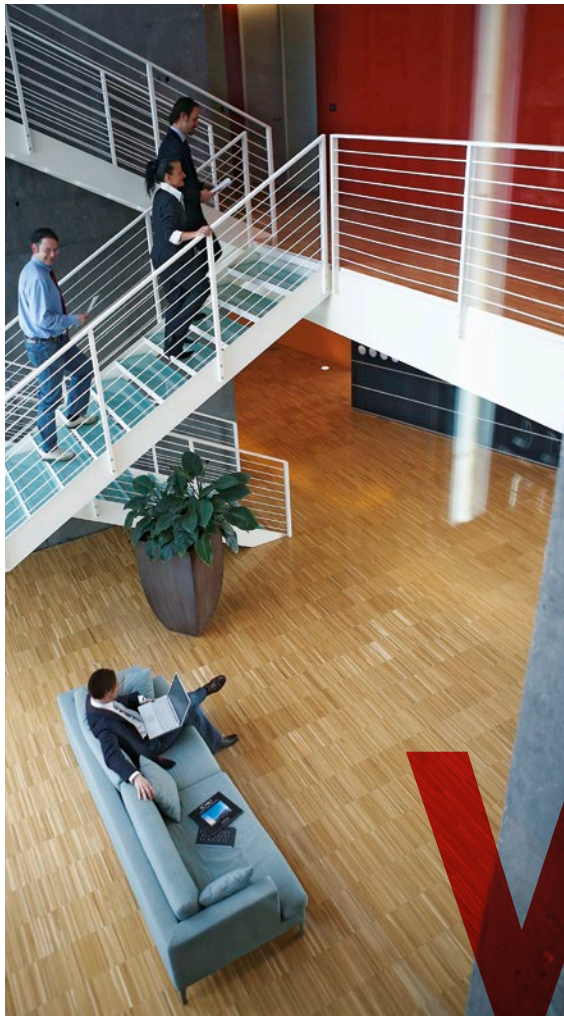





1986

Born of Videotec.
First outdoor camera housing and bracket.

1992

Opening of Videotec France.
Starting manufacturing of a line of switching matrix.

1996

First CCTV company in the industry to get the ISO9002 certification for quality.
Launch of a complete range of explosion proof certificated camera housings and P&T.

2000

Opening of Videotec Hong Kong.
New line of multiprotocol professional keyboards for the data and video control.

2003

Opening of Videotec U.S.A.
Launch of the innovative and patented VERSO camera housing.

2004

New Headquarters with 13,000sqm.



A long history of **SUCCESSES**

Videotec has a company history rich in innovation, opportunities for growth, long term strategies and successes. A lengthy path also made up of passionate enthusiasm for one's work and challenges brilliantly faced.

Over the years, thanks also to a team of well trained and motivated young managers, we have turned a small company into one of the most important concerns in Europe in the CCTV industry.

2006

New office in United Kingdom.
New line of special housings for the sophisticated thermal imaging cameras, able to get perfect CCTV images in the dark.

2007

Launch of the ULISSE range of high performance Pan&Tilt zoom camera.
Collaboration with international universities and research organisations.

2008

Starting of LEAN thinking organisation project.
Launch of a new advanced technology for the Intelligent Video Analysis in outdoor environment.

2012

Launch of the Maximus range of powerful integrated PTZ with explosion proof international certifications.
New innovative range of LED illuminators.

2013

New offices in India, Israel and South Korea.
130 employees worldwide.
Launch of a patented intelligent system (IPM) for housings, able to manage PoE Network cameras.

2014

1600 products in the range, 70% ready on stock for 24 hours delivery.
Focus on IP trend.
First enhanced PTZ (ULISSE Netcam) able to manage network cameras.
First Full HD integrated PTZ positioning system.

“
*Thanks to our focus on clients' prosperity
and well-being, all of us are better off.*
”

OUR MISSION

As a unique firm built to shape and enhance a select market, we strive relentlessly to boost our clients' growth and satisfaction with incessant efforts to cultivate our team's expertise, professionalism, and creativity.

Thanks to our focus on clients' prosperity and well-being, all of us are better off.

VALUES

Ambition

Productivity

Intelligence

Creativity

Excellence



WHY

NOW



FINANCIAL HIGHLIGHTS

ASSET COVERAGE AND EQUITY TO ASSETS RATIO

Company with high rank financial situation thanks to private financing shareholding.

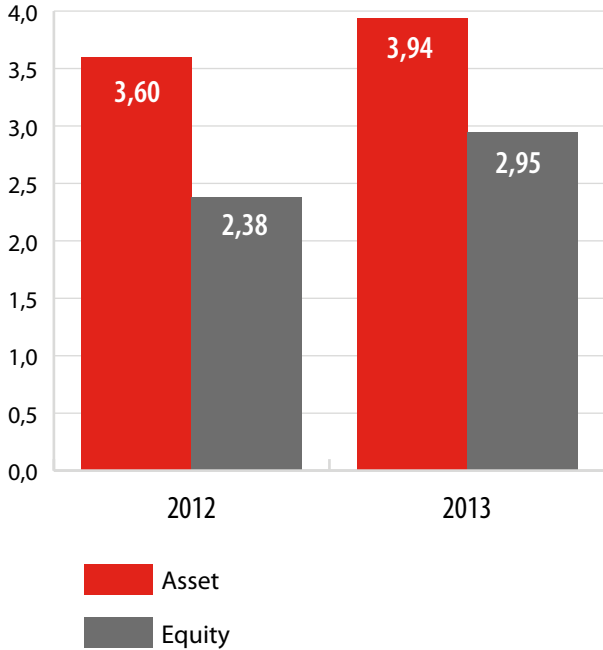

RETURN ON EQUITY, INVESTMENT AND SALES

High profit ratio between assets and sales.

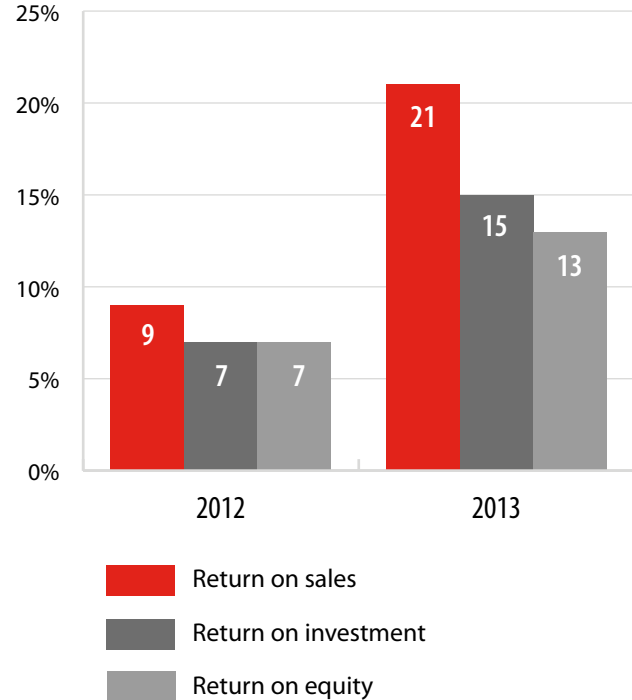

PATENTED TECHNOLOGICAL INNOVATION

Videotec's aim is to continue leading the market, anticipating its demands, projecting ourselves towards the future of new technologies with a considerable effort paid to research and development.

Thanks to a close cooperation with the university environment, we are always updated on future technologies, cutting-edge engineering techniques and materials. All this is applied to our products with the aim of devising solutions for a continually and rapidly evolving market such as ours.

Videotec owns 19 international patents, and most of them have brought great benefits to the world of CCTV. 3 brand new are under audit.

Here below we remember:

- ULISSE NETCAM First ptz in the market made for network camera
- ALBERT (smart video server) multiple patents
- VERSO side opening housing

19 international
PATENTS

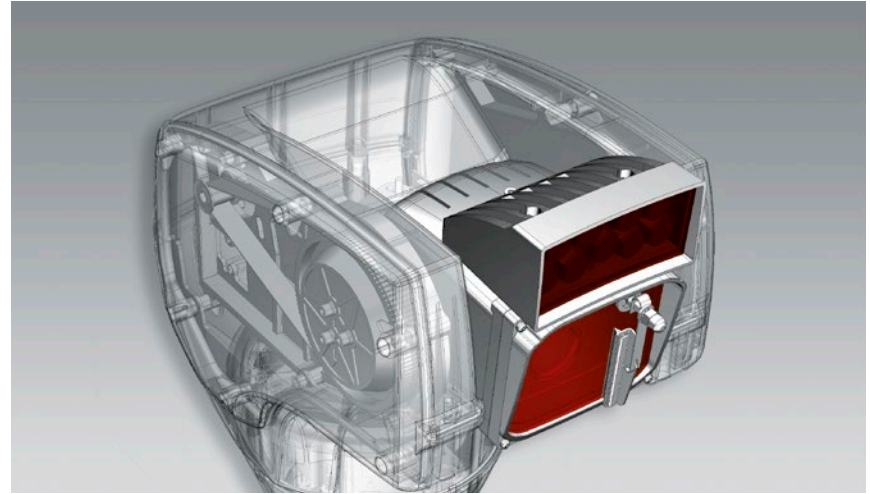



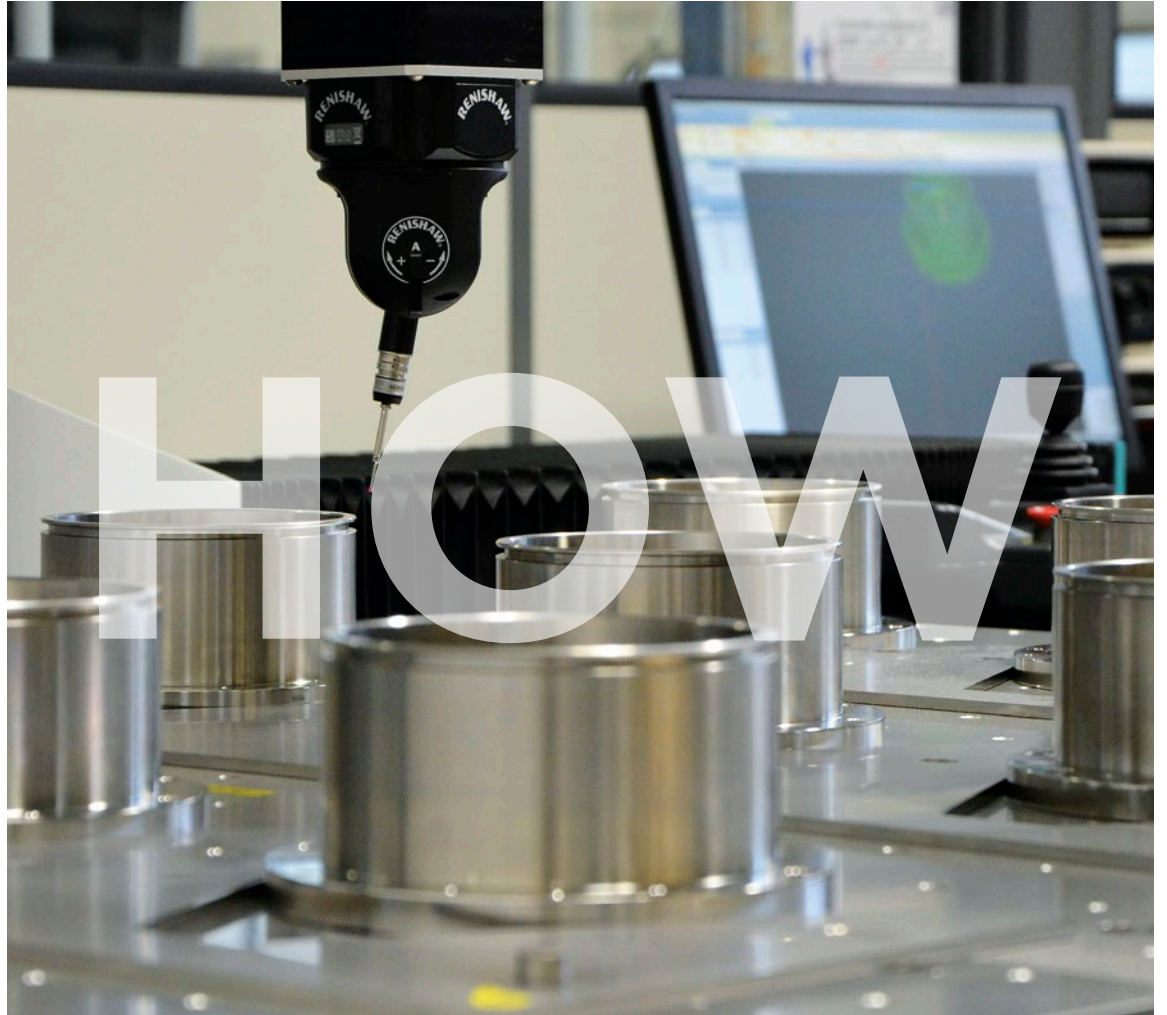

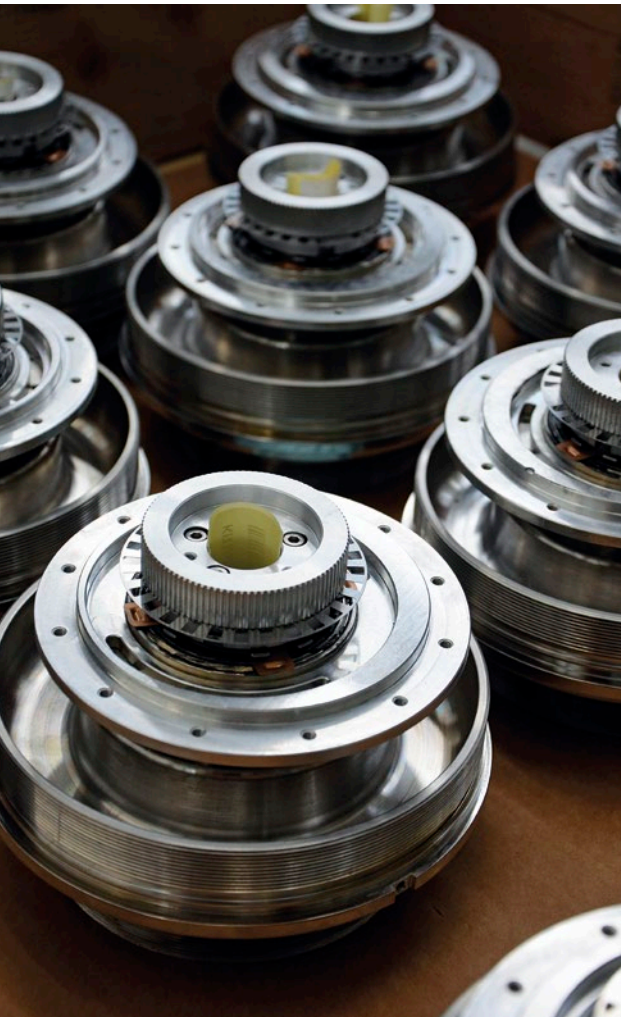

SECURITY WITHOUT COMPROMISE

We are an innovative and a unique company in our continuous effort to achieve the ultimate technology, and our clients' growth and satisfaction.

Our products are the perfect synthesis of high performance, ease of installation, durability, robustness and attention to design. The result of a passion for excellence that is the distinctive mark of the company.

We can boast a veritably spontaneous retention of customer loyalty, based on the complete satisfaction achieved by our product and service.

“ *a passion for excellence that is the distinctive mark of the company.* ”



research into new

TECHNOLOGIES



OUR PRODUCT LINE-UP

VIDEOTEC has specialized in the creation of high performance CCTV products for the monitoring of outdoor environment, keeping a close eye of the industry's ever growing needs.

WHAT



Our products are well known for their design, performance, quality. They are the results of skilled craftsmen combined with an engineering team with many years of experience in the field of video surveillance.

The wide product range includes PTZ camera positioning systems, certified explosion-proof camera systems, heavy duty housings and PTZ, night LED illuminators, video management systems, advanced artificial intelligence devices and much other.

Our products connectivity is based on high resolution analog and IP architecture, providing the highest degree of protection and immediate situational awareness, thus the response to threats and incidents is rapid and effective.



VERTICAL MARKETS: UNLIMITED FIELDS OF APPLICATION

The field of use of our broad product range is extremely vast: traffic control, urban surveillance, government applications, public and private facilities, commercial businesses, prisons, stadiums and border control.

We have a strong presence in special industries such as offshore/onshore Oil & Gas industry, marine and harbour applications, environments with high temperatures or particularly severe climatic conditions.

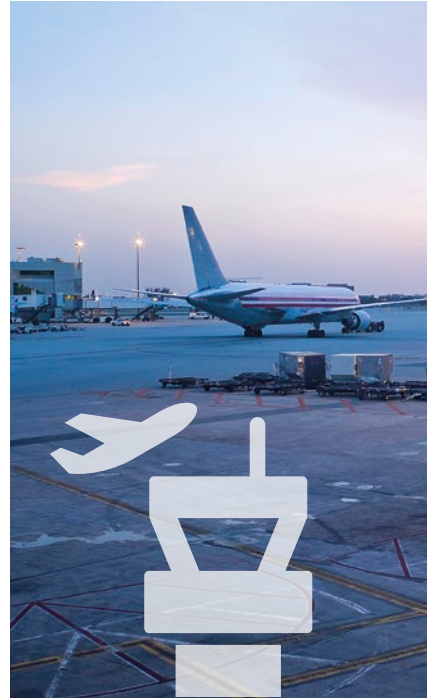

unlimited fields of
APPLICATION

A NETWORK PROVIDING PEACE OF MIND FOR EVERY CUSTOMER

The operational and logistical headquarters, covering 13,000 square metres, is located in eastern Italy. The Videotec Group has a global workforce of approx 130 people.

3 branch companies in France, USA, Asia Pacific.

4 offices in UK, Israel, South Korea and India.

Numerous select partners to form a distribution network in more than 100 countries.

We are able to supply throughout the world, in real time, a broad and complete range of products for even the most complex requirements linked to the security of outdoor environments.

We provide our clients with continuous support service, from the choice of the right product for a project, to the after sales technical assistance.

Project Installations





Global Workforce

HEADQUARTERS ITALY

VIDEOTEC S.p.A.

Via Friuli, 6 - I-36015 Schio (VI) - Italy

Tel. +39 0445 697411 - Fax +39 0445 697414

Email: info@videotec.com

FRANCE

VIDEOTEC FRANCE S.à.r.l.

Immeuble Le Montreal, 19bis Avenue du Québec, ZA de Courtaboeuf
91140 Villebon sur Yvette - France

Tel. +33 1 60491816 - Fax +33 1 69284736

Email: info.fr@videotec.com

AMERICAS

VIDEOTEC SECURITY, Inc.

Gateway Industrial Park, 35 Gateway Drive, Suite 100
Plattsburgh, NY 12901 - U.S.A.

Tel. +1 518 825 0020 - Fax +1 518 825 0022

Email: info.usa@videotec.com - www.videotec.us

ASIA PACIFIC

VIDEOTEC (HK) Ltd

Flat 8, 19/F. On Dak Industrial Building, No. 2-6 Wah Sing Street
Kwai Chung, New Territories - Hong Kong

Tel. +852 2333 0601 - Fax +852 2311 0026

Email: info.hk@videotec.com



CCV PRODUCTS



Made in Italy, since 1986

Get in Touch



•



•

